

Implants and Abutments Instructions For Use (IFU)

Version I20-0001-1802EN
2018-09-24



INTENDED USE:

Ritter Implants products are intended for use only by certified dentists and authorized persons with specific implant training. Ritter implants are used for two-stage and one-piece implantation processes. The implants are made of titanium alloy and are delivered in sterile, sealed containers. They are supplied with the understanding that only Ritter Implants surgical instruments, which complement each implant, will be used during surgery. If these conditions are not met, the manufacturer will refuse to accept responsibility.

INDICATIONS FOR USE:

The Ritter Implants are intended for simple or multiple replacements of lost teeth and provide a way to attach the prosthetic pieces in totally or partially edentulous patients.

Specific intended use for 3.0 diameter implants

Because of their reduced mechanical stability, 3.0 small diameter implants are used only in cases with a low mechanical load such as lateral incisors at the maxilla or incisors at the mandible. Placement in the posterior regions is not recommended.

Specific intended use for 6 mm length implants

Because of the reduced surface area for anchorage in the bone, these implants are to be used solely for the following indications:

- a) As an additional implant, together with longer implants to support prosthetic restoration.
- b) As an auxiliary implant for implant bar constructions supporting full dentures in a seriously atrophied mandible.



CAUTION

Warning:

"For short implants, clinicians should closely monitor patients for any of the following conditions: peri-implant bone loss, changes to implant's response to percussion, or radiographic changes in bone to implant contact along the implant's length. If the implant shows mobility or greater than 50% bone loss, the implant should be evaluated for possible removal. If the clinicians choose a short implant, then clinicians should consider a two-stage surgical approach, splinting a short implant to an additional implant, and placement of the widest possible fixture. Allow longer periods for osseointegration and avoid immediate loading."

The Ritter Implant has not been evaluated for safety and compatibility in the MR environment. It has not been tested for heating, migration, or image artifact in the MR environment. The safety of the Ritter Implant in the MR environment is unknown. Scanning a patient who has this device may result in patient injury."

POTENTIAL ADVERSE EVENTS:

Potential adverse events associated with the use of dental implants may include:

Failure to integrate; Loss of integration; Dehiscence requiring bone grafting; Perforation of the maxillary sinus, inferior border, lingual plate, labial plate, inferior alveolar canal, gingiva; Infection as reported by: abscess, fistula, suppuration, inflammation, radiolucency; Persistent pain, numbness, paresthesia;

- Hyperplasia;
- Excessive bone loss requiring intervention;
- Implant breakage or fracture;
- Systemic infection
- Nerve injury;

CONTRAINDICATIONS:

Customary observations should be made of the contraindications associated with implant materials used in oral surgery. First, the patients general health and suitability for oral surgery must be assessed by the general practitioner. It is contraindicated placing dental implants in the following patients:

1. Medically unfit for oral surgery procedure (on corticosteroids, or anticoagulants or bisphosphonates, and those receiving radiation of other immunosuppressive therapy).
2. Lactating or pregnant women are not candidates, nor are patients with abnormal laboratory values for BUN, creatinine, or serum calcium.
3. Patients with uncontrolled diabetes, cardiovascular disease, and Hypertension above 170/110 mm Hg.
4. Osteoporotic crush fractures, respiratory disease, thyroid or parathyroid as well as patients with diagnosed malignancy disease or unexplained lump or masses in the head or neck.
5. Patients with uncontrolled disease such as; Hemophilia, Granulocytopenia or other bleeding problems, steroid use, Prophylactic antibiotics use, Brittle diabetes, Ehler-Danlos syndrome, Osteoradionecrosis, Renal failure, organ transplantation, Anticoagulation therapy, unexplained hypersensitivity, Fibrous dysplasia, regional enteritis.
6. Diseases, or treatment that severely compromise healing, e.g., including radiation therapy.
7. Lack of adequate training of practitioner.
8. Poor patient motivation, such as; Psychiatric disorders that interfere with patient understanding and compliance with necessary procedures, Unrealistic patient expectations, Unattainable prosthodontic reconstruction, Inability of patient to manage oral hygiene, Patient hypersensitivity to specific component of the procedure.
9. Electrosurgery: Dental implants are made of a metallic alloy; therefore, they are characterized by high conductivity. For this reason, electrosurgery is strictly contraindicated near dental implants.

Temporary Contraindications

1. Systemic infection, local oral and respiratory infection
2. Anatomical or Pathological implications such as:
 - a) Insufficient alveolar bone width and height to surround the implant with at least 1.5 millimeter of bone
 - b) Inadequate bone height where proper implant placement would encroach within 2mm of the mandibular canal, sinus floor, etc.
3. Malignancies
4. Pregnancy
5. Inadequate bone volume unless augmentation procedure can be considered.

WARNINGS:

1. These devices are only to be used by trained professionals. The surgical and restorative techniques required to properly utilize these devices are highly specialized and complex procedures. Improper technique can lead to implant failure, loss of supporting bone, restoration fracture, screw loosening, and aspiration. Therefore, no implantation should be performed without prior adequate training by a certified dentist.
2. With respect to pediatric patients, routine treatment is not recommended until the end of the jawbone growth has been properly documented.
3. This product is a single use device. Any attempt to reuse the device may cause severe risk to health such as product contamination, acute infection, degradation of mechanical properties leading to painful revision surgery for replacing the implant.
4. Do not use implants if the packaging is opened or damaged, as this can result with compromising sterility or device malfunction.
5. BREAKAGE Implant and abutment fractures can occur when applied loads exceed the normal functional design tolerances of the implant components. Potential overloading conditions may result from deficiencies in implant numbers, lengths, and/or diameters to adequately support a restoration, excessive cantilever length, incomplete abutment seating, abutment angles greater than 30 degrees, occlusal interferences causing excessive lateral forces, patient parafunction (e.g., clenching), improper casting procedures, inadequate prosthesis fit, and physical trauma.
6. Do not use excessive force exceeding insertion torque of 60Ncm: Over tightening an implant may lead to damage of the implant and/or internal connection, fracture or necrosis of bone site, compromising osseointegration.
7. Balanced occlusion.
8. Proper cementation.
9. Follow up of the patients.

Instructions for use - implants

GENERAL DISEASES AND MEDICATIONS:

Cardiovascular disorders associated with high endocarditic risk (SBE); Coronary insufficiency; Blood dyscrasias; Immuno-deficiency; AIDS; Cancers and radiation of the facial region in the past five years; respiratory disease; Thyroid or parathyroid disease; Patients with nodular enlargements, or inexplicable lumps on the head or neck region; Bone metabolism disorders; Diabetes; Hypertension above 170/110 mmHg; Drug abuse, alcoholism; Titanium hypersensitivity; Patients on corticosteroids, anticoagulants, anticonvulsive, an immune suppressant therapy; patients with abnormal values for creatine, BUN or serum calcium; Hemophilia; Granulocytopenia; Steroid use; Prophylactic antibiotics ; Ehler-Dan-los syndrome; Renal failure; Organ transplantation; Fibrous dysplasia.

SURGICAL RECORD- MANDATORY INITIAL INVESTIGATIONS:

Patient examination; Patients medical history; Clinical examination of patient's hygiene, teeth, occlusion, periodontium; Biological observations; Radiographic evaluation: CT scan, intra-oral, x-rays, pan-oral, etc. Lack of adequate practitioner training is one of the major factors influencing the success of implant surgery and subsequent long-term patient health.

SURGICAL AND RESTORATION PROCEDURES SURGERY:

The hard and soft tissues must be carefully managed, to ensure osseo-integration. The site must be prepared with extreme precision. Any ancillary instruments employed must be properly sterilized. The surgical procedure requires drilling speeds from 1000 rpm for the first drill to 500 rpm or the last one. Physiological saline must irrigate the area, while the culling sequence must be strictly adhered to. Thermal trauma will be reduced if these procedures are followed. The implant size (height and width) is chosen according to preliminary X-rays. There must be a 2-mm margin from anatomical obstacles and maximum bone height. • The implants are provided in sterile condition.

- **Implants are not to be re-sterilized.**
- **Implants are for single use only.**
- **All devices should be placed in a sterile surgical field during surgery.**
- **The shelf life of the devices is 5 years.**



SB/LA Spiral Implant
SNAP & NL-SNAP



QSI & NL-QSI
Ri-Quadro Spiral
Implant



TFI
Ri-Twin Fissure
Implant



MCI
Mono one-piece
Implant



CAUTION: FEDERAL LAW RESTRICTS THIS DEVICE TO SALE BY OR ON THE ORDER OF A DENTIST !

GUIDE TO CHOOSING THE PROPER IMPLANT:

After making a preliminary diagnosis, an X-ray and/ or CT, in conjunction with a transparency that displays the necessary measurements, should be used to determine the dimensions of the implant suitable for the site in question. As a general rule, the widest and longest implant suitable for a particular site (density and dimensions of bone, dimensions of gums) should be used, in order for rehabilitation to be most effective. Another general rule is that implant and abutment combinations offer the greatest range of rehabilitation options. The use of the integrated implant offers some advantages that a peel to certain patients, and are appropriate for them. The choice of an integrated implant/abutment (one-piece) requires immediate loading and rehabilitation, and cementing of the restoration device. There is no affixing of the abutment by screw, and no choice as to the structure of the abutment. That choice is made beforehand. In a two-stage implantation, if there is a need for immediate loading, the spiral conical implant (QSI), which has good retention from the outset, should be used. In the lower jaw in Type 1 hard bones the SB/LA SNAP, TFI, QSI implants are suitable. In the front, single-rooted teeth and in the upper teeth between tooth 4 and tooth 7, where the sinus cavity is found, wide conical implants are recommended in order to reduce pressure on the base of the sinus. When the bone is very wide, and the sinus cavity is distant, any implant can be used. When the bone is narrow, a wide implant should not be used. Following extraction, if the bone is good, a spiral implant (QSI or SNAP), or immediate loading, is appropriate.

TFI: A Twin Fissure Implant - available in narrow (3,3 mm) up to (5 mm) platforms. Recommended for use in hard bone type 1, anterior area.

SB/LA Spiral Implant (SNAP), QSI & NL-QSI:

A Spiral conical implant, with deep, wide gap threads, especially high-sharp-thread edges and a grooved neck. Its advantages are: the deep threads increase the surface area, and hence improve the retention of the implant; while the implant is inserted by rotations into the bone, the sharp thread edges generate their path in the bone tissue. As deep as the implant is inserted the bone becomes more condense, due to the conical structure of the implant; excellent initial retention.

MCI:

A mono one-piece slim integral implant intended for immediate loading. It is appropriate for Types 1, 2 & 3 bones, and also for narrow and buccal plates, on narrow ridges, and between closely spaced implants or teeth. It is also used between permanent implants, which need relief during their osseo-integration. Temporary restoration is cemented upon the middle MCI implant which eliminates the stress upon the neighbouring implants. This implant is used in space limited areas.

-DRILLING PROCEDURE -

ALL IMPLANTS: After good surgical exposure of the bony surface, the position for the implant should be determined and a guide hole should be made using our round-head bur, taken down into the cortical bone to the level of the neck beneath the bur head. Do not attempt to drill deeper with the round bur using the guidehole for position; the color-coded drill bits will be utilized to drill the hole to the desired depth. The color coding on the bits indicates the diameter of the bit. Almost all drilling (Excluding all MCI) should commence using the 2.0 millimeter bit or lance drill. The bits are used in graduated order to slowly increase the diameter of the implant hole until the desired diameter is reached. This will allow safe progression and decrease trauma to the surrounding bone structures. The accurate depth of the hole is determined by the length of each particular implant and is indicated by the depth lines around each bit, in order to allow good position of the implant in the bone so that its end is flush with the alveolar ridge.

QSI/SNAP- PROTOCOL:

The best conical hole for the planned conical implant is achieved by using the appointed conical drilling bit. All bits, with the exception of the final regular bit, are inserted in turn till the required depthline reaches the alveolar ridge. The final regular bit is inserted gently to a depth of only the necessary situation. The drilling protocols of tapered holes are presented in Table A. Ritter conical drills CDEP have a Stopper-system included which assures correct drilling depth, preventing drilling deeper than required.

The most efficient method of drilling has been found to be achieved through the use of conical drilling bits. We highly recommend that our customers acquire the conical drilling bits. The conical drilling bit for each diameter is suitable for every implant length in that diameter. Where the conical drilling bits are not available, it is possible to achieve the desired tapering of the hole by re-drilling with two slightly larger bits taken down only to a partial depth. The first bit, slightly larger than the bit used to reach the desired depth of the implant hole, drills only 2/3 of the total depth, and the second, slightly larger than the first, drills only 1/3 of the depth, thus creating a staged or conical tapered hole.

TFI - PROTOCOL:

The final diameter of the hole should be approx. 0.5 mm smaller than the implant diameter (e.g. for an implant with a diameter of 3.75 mm, the final bit size would be 3.2 mm). Table B summarizes the final color-coded drill for each implant.

Implant Diameter	NL-3	NL-3.3	3.75	4.2	5.0	6.0
Color Code	white	red	blue	green	black	brown
Preceding regular drills CDEP	--	1	1	2	3	4
Conical Bit width CDEP	--	2.8	3.2	3.2-3.65	3.2-4.5	3.2-5.4
Final regular drill with max. depth / accordingly to the length of the implant	2.5	2.8	3.2	3.65	4.5	5.4



Implant Diameter		3.3	3.75	4.2	5.0	
Color Code		red	blue	green	black	brown
Preceding regular drills CDEP		1	1	2	3	
Conical Bit width CDEP		2.8	3.2	3.2-3.65	3.2-4.5	
Final regular drill with max. depth / accordingly to the length of the implant		2.8	3.2	3.65	4.5	



MCI - PROTOCOL:

Preferably, the 2.4mm conical drill bit is inserted till the required depth line reaches the alveolar ridge. Table C summarizes the brief drilling procedure when using the conical drill bit. Where the 1.8-2.4mm and the 2.0-3.2mm conical drill bit is not available, it is possible to use the regular drill bits instead, but it should be inserted only till the depth line below the nominal one reaches the alveolar ridge.

Tables C also summarize the drilling sequence and depth for each implant when not using the conical drill bit. (Only lance drills with 2.0-2.8 mm are necessary).



CAUTION: As the lance drills have no stopper-system included, the drilling process must be done carefully in order to drill not deeper than 6mm!

Table C: The recommended conical drills for each implant diameter:	MCI 2.8	MCI 3.2	Implant length 10 mm	Implant length 11.5 mm	Implant length 13 mm
Implant Diameter	2.8	3.2			
Max. drilling depth in mm	--	--	8	10	11.5
Preceding drills	1	2			
Lance drill	2.0	2.0-2.8			
Final Regular Bit with max. depth / accordingly	2.0	2.8			



CAUTION:

All conical drill bits are characterized by drilling through the bone along the entire length of the drill that is positioned inside the gums. This is as opposed to the regular drill bit, which only drills through the bone using the frontal lower tip. The same time, its side helical blades slide along the wall of the hole without any significant radial forces. The use of conical drill bits causes extreme radial pressure, creating the necessity for gentle, probing drilling instead of constant drilling. This gradual drilling should include the use of a low torque.

The maximum rpm (rounds per minute) is dependent upon both the type of one and the drilling diameter. Do not exceed 450 rpm and torque of 35 Ncm. Drilling should be accompanied by intensive irrigation. First you must drill with drill bits in a slow gradient - first the 2.0mm bit, then 2.8mm bit and so on as necessary. The conical drill bit is only to be used at the end of the drilling process so that only a small amount of bone will have a quicksand effect. The hard bone drills may be used to widen the crestal bone at the end of the drilling sequence (CD 3.75-6.0).

EXAMPLE: When desired to insert a 6.0mm implant you must use the final regular drill CDEP-5.4 for the 6.0mm implant. Pausing periodically during the drilling allows both the blade and the bone to cool down. It also allows for the removal of bone fragments as well as the control necessary at the appropriate rpm. The drill should be moved up and down during drilling to prevent too much heat and pressure or even microsis. (Branemark Bone Dancing Method)

SB/LA Spiral Implant -SNAP- IMPLANTATION PROTOCOL:

After the implant is removed from its double tubes its sterility should be maintained. The implant must be inserted directly via Mountdrivers (MMIB long or short with ball friction) via handpiece which can be put directly into the implant. MMIB has a SD adaptor of the hand-piece. Once putten the MMIB in the inner HEX of the implant, a small bend with the hand-piece to the side will release the implant from the titanium implant holder/shaft. After insertion the implant can be closed at the top with a cover screw (ICS) and the wound must be sutured and for recovery and healing period. For immediately loading: install the proper temporary abutment, and suture tissue around.

CAUTION: NL-SNAP: Requires NL-Narrow Line instruments Hex-2.0 (NL-RDH, NL-MMIB)

TFI & QSI IMPLANTATION PROTOCOL:

After the implant is removed from its double wrapping its sterility should be maintained. The implant is screwed manually via the carrier, and/or the SDH and/or HDH tool, and/or the RHD tool, and/or the RWH/TRU ratchet, or via a hand piece with the MMIB adaptor mounted in it, with or without the carrier, as required. The recommended position for perfect restoration is achieved by reaching the exact height, with one of the hexagon's sides tangential to the external jaw arc. The carrier's visible external hexagon is always parallel to the implant's hidden internal hexagon. The carrier is separated by a slight pull. One can close the implant top with a cover screw (ICS), stitch, and wait for recovery, or load immediately by installing the proper abutment, and stitch tissue around.

CAUTION: NL-QSI: Requires NL-Narrow Line instruments Hex-2.0 (NL-RDHI, NL-SDH, NL-HDH & NL-MMIB)

MCI- IMPLANTATION PROTOCOL:

After the implant is removed from its double wrapping its sterility should be maintained. The implant is screwed manual via the carrier or RHDM tool, and/or the HDH tool, And/or the RWH ratchet, or via a hand piece with the MDE/I adaptor mounted in it, with or without the carrier, as required. The recommended position for perfect restoration is achieved by reaching) the designed depth. The carrier is separated by releasing the fastening screw; immediate loading is achieved by cemented restoration. There is no retaining screw. Tissue is stitched around. Complete the screwing motion with a torque wrench (RWH) up to 30 Ncm. In one-piece integral implants (MCI), the mechanical preparations (grinding) are optional.

STERILIZATION:

Implants should NOT be cleaned and re-sterilized under any circum-stances !! Do not autoclave hard plastic items, which can melt at approximately 338°F (170°C). Abutments are provided non-sterile and should be sterilized prior to placing them in the oral cavity. For sterilization see Page 11. Sterilization of prosthetic components.

SPECIAL INSTRUCTIONS FOR MAINTENANCE OF SURGICAL TOOLS:

Correct and careful maintenance of surgical tools is extremely important. Damage to drill tips can cause significant impairment of drill function. Following are detailed instructions for proper maintenance.



Cover screw

Carrier

Implant

Internal Tube

INSTRUCTIONS FOR MAINTAINANCE OF SURGICAL TOOLS PRIOR TO FIRST-TIME SURGICAL USE:

For Information about surgical Kit System, cleaning and sterilization of drills and instruments see instructions For Use I20-0002 "Surgical Kit System".

RECOMMENDATIONS:

• Cutting tools should be used for a maximum of 10 cycles. • Sterilized water should be used in order to avoid surface stains.

STORAGE: The implants should be kept in their original packaging, in a dry area at room temperature (10°C-35°C/ 50°F-95°F). The implant should not be used after the expiration date on the package. Light packages should be stacked on top of heavier ones. Do not store implants near dangerous or toxic materials.

Transport: The implants should be kept in their original packaging, in a dry area at 2°C-50°C/ 36°F-122°F.

WARNINGS: Implant surgery is a highly complex procedure and practitioners are advised to take the necessary courses that teach implant surgery. Improper implant techniques may result in implant failure and loss of bone. Ritter Implants are intended to be used only according to the protocol outlined above with Ritter implant drill bits. Implants placed at sharp angles may lead to implant failure. Bone loss, infection and movement of the implant may indicate that the implant is failing. If any of these is observed, the problem should be treated or the implant removed, as soon as possible. Patients should consult with their physician and imaging technician prior to undergoing an MRI procedure. Ritter implants and prosthetic components have not been evaluated for safety and compatibility in the MR environment and not been tested for heating or migration in the MR environment. Risks include: immediate anesthetic and surgical risks psychiatric risks, medical threats to long-term retention, long-term effects on health, and complications that may include: delayed healing, edema, hemorrhage, dehiscence, parenthesis, hematoma, allergic reaction, inflammation of the sinus, nerve damage, speech problems, and gingivitis long-term problems may include: nerve damage, bone loss, hyperplasia, local or systemic bacterial infection, endocarditic, long-term pain, and fractures of the bone, the implant or the teeth. The following organ systems may be affected: cardiovascular -coronary heart disease arrhythmias; Respiratory - chronic pulmonary disease; Renal - chronic renal failure; Endocrine - diabetes, thyroid disease, pituitary and adrenal disorders; Hematologic -anemia, leukemia, blood clotting disorders; Musculoskeletal- arthritis osteoporosis; Neurologic-stroke, palsy, mental retardation.

CHANGES IN PERFORMANCE: It is the responsibility of the clinician to inform the patient of the side effects, contraindications, and precautions, should the performance of the implant be called into question. If any of the side effects occur, it is the responsibility of the patient to seek a trained professional immediately.

PRECAUTIONS: Adequate palpation and visual inspection of the future implant site must be carried out in order to determine if there is sufficient quality and volume of bone for an implant. After implant failure, the quality and volume of residual bone must be evaluated. The implant is supplied in sterile packaging. Do not re-sterilize. An opened, damaged, or defective package should be returned to the supplier for free replacement. The use of an implant does not require the use of any unusual preoperative antibiotic prophylaxis. In the case of unexpected pain, the surgeon must be contacted immediately physical exertion should be avoided following surgery. Patients must be informed that the implant is a metallic device and may effect the performance of MRI apparatus.

HYGIENE AND MAINTENANCE: The quality of oral hygiene directly affects the long-term success of the implant. The patient should be instructed on the use of the proper tools and the maintenance of oral hygiene for preserving implant health, and should visit a dental professional for periodic check-ups and regular cleaning. Ritter Implants GmbH & Co. KG high quality Implants are made according to strict international standards. This is why we can provide you with a Lifetime Warranty for our range of Implants. In any case of a defect in the implant, implant rejection, fracture or contamination of the product, Ritter Implants GmbH & Co. KG shall replace the defective merchandise, providing that a complaint report was filled. A complaint report is available at Ritter Implants customer service and will be sent upon request.

LIMITED WARRANTY: In the case of failure of an implant, Ritter will replace/provide another implant in exchange free of charge, in accordance with the following conditions:

- Filling in a report form supplied by Ritter and attaching a radiogram taken before and after implantation.
- Submitting the report no later than 6 months from the beginning of the event, with the failed implant.

This is the full scope of the warranty for implantation provide by Ritter that lists the sole remedies related to implantation.



Titanium



Burn-IT



Zirkonium



PEEK

RITTER IMPLANT'S ABUTMENTS for Ritter IMPLANT SYSTEM.

INDICATIONS FOR USE:

The Ritter Implants are intended for single or multiple replacements of lost teeth and provide a way to attach the prosthetic pieces in totally or partially edentulous patients.

Operating surgeons/ practitioners should be fully familiar with all indications, contraindications, recommendations, warnings and instructions, as well as all other product-specific information (technical product description, description of the surgical and restorative technique, catalogue sheet, etc.) of our system. They should be able to fully comply with these processes. Detailed instructions beyond those contained in these instructions for use concerning the possible combinations, product specific risks, preparatory steps, indications, contraindications, etc. can be found in the product descriptions. These include of the surgical technique and descriptions of the product(s) as found in the appropriate catalogue sheet. Ritter also recommends attending appropriate education, continuing education and user-training courses. The afore mentioned documents and details of the training courses may be obtained from the complications, other negative effects or damages that might occur for reasons such as incorrect indications or surgical technique, unsuitable choice of material or handling there of unsuitable use or handling of the instruments, asepsis and so on. The operating surgeon is responsible for any such complications or other consequences. It is also the operating surgeon's responsibility to properly instruct and inform the patient on the functions, handling and necessary care of the product and on all known product risks.

Location in the mouth:

- Straight - Located in all the sectors (areas) of the mouth.
- Angled - Located in the anterior sector (areas) of the superiormaxillar (upper jaw) for 15° angled abutments. Sectors where the defects existing made impossible implant perpendicular tooocclusal plane 25° angled.
- Ball Attachment/Clicq Overdenture/Multi-Unit systems- Located in all the areas of the mouth but usually used in the anterior area for overdentures.
- Healing Abutments / caps - Located in all the areas of the mouth.

Sources for Occlusal Load: • Estevam Barbosa dc LAS CASAS, Andre France de ALMEIDA, Carlos Alberto CIMINI EJUNIOR, Paulo de Tarso VidaGUMES ,Tulimar Pereira Machado CORNAC- CHIA. Jorge Milton Elian SAFFAR. Determination of Tangential and Normal Components of Oral Forces journal of Applied Oral Science.2007;15(1)70-6 • Lucas D. Movement behavior of teeth and dental implants in periotest measurement in oclusion - an in vitro study, Biomed Tech(Berl). 2001 Nov; 46(11):311-9. PMID: 11778315 [PubMed - indexed for MEDLINE]. • Lyons M.F. y Baxendale R.H. (1990). A preliminary electromyographie study of bite force and jaw-closing muscle fatigue inhuman subjects with advanced tooth wear. Journal of Oral Rehabilitation 17: 311-318. • Waltime A., Kempainen P. y Kononen K. (1993). Maximal contraction force and endurance of human jaw closing muscles inisometric clenching. Scandinavian Journal of Dental Research 101: 416-421.

DESCRIPTION: The restorative abutments have a hex which engages the internal hex of the SNAP, QSI and TFI implants. The abutments are available in multiple cuff heights in straight and offsets in both 15° and 25° angulated configurations to provide correction for off-angle implant placement. The abutment is secured to the implant with an abutment retaining screw which is preassembled in the abutment. The abutment screw is not removable from the abutment. The abutment has an internal screw access for the attachment of various restorative components using a separate coping screw. Abutments are packed with a screw in a blister. The abutment and abutment retaining screw are fabricated from titanium alloy.

INDICATIONS: The straight and angled abutment are used for a terminal or intermediate abutment for screw-retained multiple-unit restorations. The 25° Angled Abutment must be used within 45° of parallelism for a splinted restoration. The 15° Angled Abutment must be used within 30° of parallelism for a splinted restoration.

CONTRAINDICATIONS: The system is not for use with limited interocclusal space less than 7.0mm. It is not for use when implants are divergent greater than 45° with the 30° Angled Abutment or when implants are divergent greater than 30° with the 15° Angled Abutment. The Angled Abutment may not be excessively prepped. The Narrow Line (NL) of implants has a similar type of abutments. The NL-QSI Implants (Narrow line) are available in Straight and 15°. The NL abutments are designed only for the NL-QSI and NL-SNAP 3.0mmD and 3.3mmD. Ritter dental implants should not be placed if there is an insufficient volume of alveolar bone to support the implant (minimum 2mm circumferential and 2mm apical). Implants placed in the maxilla should not perforate the sinus floor membrane. Poor bone quality, poor patient oral hygiene, heavy tobacco use, uncontrolled systematic diseases (diabetes, etc.), reduced immunity, alcoholism, drug addiction, and psychological instability may contribute to lack of integration and/or subsequent implant failure. Severe bruxism, clenching, and overloading, may cause bone loss, screw loosening, component fracture, and/or implant failure. Exposure to radiation and chemotherapy may impact health and success of the implant. Dental implant patients should be instructed to consult with their physician prior to undergoing such treatment options.

Abutment Dimension & Characteristic (Material: Ti6AL-4VELI)

Abutment Titanium	Lenght in mm (L)	Shoulder Hight	Characteristical usage
Anatomic	8-10	1-3	for Casting
Angulated 15°/25°	8-15		for Restoration
Ball Attachment & Clicq Overdenture	1-7	--	for Overdentures
Esthetic Straight	8-12	1-4	for Restoration
Esthetic Angled 15°/25°	8-10	1-3	for Restoration
Esthetic Anatomic with Platform Shifting	8-12	2.5-3.5	for Restoration
Straight Titanium	7-15	--	for Restoration
Straight Anatomic	8-12	1-4	for Restoration
Slim Titanium	5-10	--	for Restoration
Healing	2-7	--	for Healing and Tissue modelling
Overdenture Connection	3-6	0.5-2.5	for Overdentures
Plastic Connection with Hex and non Hex	8	--	for Casting
Multi-Units	7-15	1-5	for Restoration



Abutment PEEK / Burn-IT	Lenght in mm (L)	Shoulder Hight	Characteristical usage
Burn-It Plastic For Lab with Hex and non Hex	15.2	1	for Casting
Burn-It Straight Anatomic Plastic Abutment	10.5-12.5	1-3	for Casting
Burn-It Esthetic Angled Plastic Abutment	8.5-11.9	1-3	for Casting
Straight Anatomic Golden Titanium	8-12	1-4	for Restoration
Peek-On Peek Anatomic Straight	10.5-12.5	1-3	for temporary Restoration
Peek-On X-Shape	8.4-9.4	0.5-1	for temporary Restoration
Peek-On Esthetic Angled Peek	8.5-11.9	1-3	for temporary Restoration
Peek-On X-Shape Angled Peek	8.4-9.4	0.5-1	for temporary Restoration



Abutment Dimension & Characteristic (Material : Zirconium)

Abutment Zirconium	Lenght in mm (L)	Shoulder Hight	Characteristical usage
Zirconium	8	2	for Restoration
Zirconium Anatomic Straight	10.5-12.5	1-3	for Restoration
Zircorit X-Shape Straight Zirconium	8.4-9.4	0.5-1	for Restoration
Zircorit Esthetic Angled Zirconium	8.5-11.9	1-3	for Restoration
Zircorit X-Shape Angled Zirconium	8.4-9.4	0.5-1	for Restoration



WARNINGS:

Surgical and restorative techniques required to place dental implants are highly specialized and complex procedures. Surgeons and all practitioners should be fully trained in such procedures and be competent in such implant practices. All practitioners should attend courses of study to familiarize themselves with implantology techniques. Improper technique can cause bone loss and implant failure. Ritter Dental implant systems are intended to be used only with Ritter Dental specially designed bone drills and prosthetics. Implants placed at severe angles relative to existing dentition or multiple implants placed at convergent/divergent manner can result in complex restorations that may overload implants. This overload may lead to the implant or its prosthesis. A thorough diagnostic work-up and use of a surgical template is recommended to help ensure proper positioning of the implant or implants. Relative contraindications include the use of steroids, chemotherapeutic agents, bisphosphonates and anticoagulants. These and other medicines which may effect the surgical site, surrounding tissue, or patient's healing function can impact the success of the implant. Careful patient selection including consultation with the attending physician is strongly recommended prior to implant treatment for patients on any such medication. Placement of an implant adjacent to an infected tooth or a failing root canal treated tooth may cause the implant to fail. Excessive mobility, bone loss, or infection may indicate the implant is failing. Any implant which appears to be failing should be treated or removed as soon as possible. If removal is necessary, curette any soft tissue from the implant site. One may either allow site to heal as though it were an a traumatic extraction or perform guided tissue regenerative procedures as indicated. Due to the metal conductivity, electro surgery around the implants and intraoral abutment preparations without irrigation could result in tissue damage and implant failure. Patients should consult with their physician and imaging technician prior to undergoing an MRI procedure. The Straight and Angled Abutment have not been evaluated for safety and compatibility in the MR environment. The Straight Angled Abutment has not been tested for heating or migration in the MR environment.

PRECAUTIONS: Proper case planning is essential to the long-term success of both the prosthesis and the implant. Overload is one of the key contributors to implant failure. One should ensure the implant size and abutment angulations are appropriate for the occlusal load. Highly angulated abutments (>25°) should be avoided and are not recommended. Splinting of off-axis loaded implants may be required to give better support.

BREAKAGE: Implant and abutment fractures can occur when applied loads exceed the normal functional design tolerances of the implant components. Potential overloading conditions may result from deficiencies in implant numbers, lengths and/or diameters to adequately support a restoration, excessive cantilever length, incomplete abutment seating, abutment angles greater than 25 degrees, occlusal interferences causing excessive lateral forces, patient parafunction (e.g., bruxing clenching), improper casting procedures, inadequate prosthesis fit, and physical trauma.

CHANGES IN PERFORMANCE: It is the responsibility of the clinician to instruct the patient on all appropriate contraindications, side effects, and precautions as well as the need to seek the services of a trained dental professional if there are any changes in the performance of the implant (e.g., looseness of the prosthesis, infection or exudates around the implant, pain, or any other unusual symptoms that the patient has not been told to expect).

HYGIENE & MAINTENANCE: Long-term implant health is directly related to the maintenance of oral hygiene. Potential implant candidates should establish an adequate oral hygiene regimen prior to implant therapy. Following implant placement, the clinician should instruct the patient on proper tools and techniques to ensure long-term maintenance of the implant(s). The patient should also be instructed to maintain routinely scheduled prophylaxis and evaluation appointments.

TREATMENT PLANNING: Appropriate imaging techniques should be used to determine if adequate bone is available, and to determine the location of important anatomical landmarks, such as the mandibular canal, maxillary sinuses and adjacent teeth. Thorough clinical evaluation is imperative prior to all implant surgeries.

GENERAL CONSIDERATIONS: Control of biomechanical stresses is the key factor to long-term success of the prosthesis. Even after implant integration, imbalances in occlusal forces can lead to implant failure. Implant patients should be monitored for signs of screw loosening, periimplant bone loss and tooth wear as signs of occlusal overloading.

ADVERSE EFFECTS: The following complications may occur relative to implant placement: pain, discomfort, dehiscence, delayed healing, paresthesia, hyperesthesia, edema, hemorrhage, hematoma, infection, inflammation, local and generalized allergic reaction, lack of integration, damage to adjacent teeth, loss of bone or teeth, and loss of implant. Other adverse effects may also occur as a result of iatrogenic factors and host responses.

STERILITY: Abutments are delivered in unsterile condition, packed under Cleanroom condition.

SINGLE USE: Reuse of a single use device that has come in contact with blood, bone, tissue or other body fluids may lead to patient or user injury. Possible risks associated with reuse of a single use device include, but are not limited to, mechanical failure and transmission of infectious agents.

SHELF LIFE: The product expiration date is indicated by the hourglass symbol on the product label, followed by the year and month of expiration. Caution: Do not use sterile devices if the packaging providing the sterile barrier, including the outer cap, vial, or tray has been damaged or compromised in any manner (i.e. cracked or crushed).

PRODUCT PACKAGING: All implants have been cleaned, packaged in double tubes within an environmentally controlled room, and sterilized for convenience and immediate use. The implants are suspended on a carrier of titanium shaft for safe transfer to the prepared surgical site without risk of contact contamination. Both the implant and the inner tube packaging are sterile. The label on the outer blister packaging for each implant contains a lot number that should be recorded in the patient's file to ensure complete traceability of the product. Prosthetic components provided in sealed blister packages are also pre-cleaned for your convenience.

CLEANING/STERILIZATION INFORMATION: Disinfection and sterilization procedures should conform to OSHA or local guidelines for blood borne pathogens. Clinically contaminated implants should not be cleaned and resterilized for reuse under any circumstances.

CLEANING: Use the following guidelines for cleaning prosthetic components: Disassemble multi-piece components, if applicable. Rinse with cool-to-lukewarm water for two-and-one-half minutes. For all parts place in an ultrasonic cleaner with an enzymatic detergent diluted with tap water per the manufacture's guidelines. Ultra-Sonicate for 10 minutes. Rinse with tap water for three minutes. Clean parts per the above instructions. A syringe or a pipe cleaner may be used to aid in the cleaning. Dry the components. Follow the guidelines for sterilization.

STERILIZATION:

1. Please unpack the NON-sterile prosthetic components from carton- and blister box before autoclaving.

Prosthetic Components (Abutments) should be placed in appropriate autoclave or dry heat pouch prior to sterilization. The following sterilization parameters (method, time and temperature) are required to achieve a 10⁻⁶ sterile-assurance level (SAL). Local or national specifications should be followed where steam sterilization requirements are stricter or more conservative than those listed in the table. Exceeding these sterilization parameters may result in damage to plastic components. Verify the calibration of your unit to ensure recommended temperatures are not being exceeded. To ensure autoclave is performing effective, periodic use of biologic indicators should be considered. Chemclave sterilization is NOT recommended for any Ritter Implants Dental products.

Sterilization of prosthetic components	Cycle Type	Temperature	Exposure time in Minutes	Drying Time in Minutes
	Gravity (steam)	132°C/270°F	15	15
	Vacuum Steam Autoclave	132°C/270°F	5	20-30
	Vacuum Steam Autoclave	134°C/273°F	5	16

TECHNICAL INFORMATION: Procedure for Ritter Implants **angled abutments.**

NOTE: During implant placement, it is recommended to orient the flat of the internal hex of the implant to be opposite the angle correction. The pre-attached multi-purpose fixture mount can be used to index the internal hex of the implant. The flat side on the wall of the fixture mount will line up with the flat side of the internal hex. NOTE: To put the abutment in the mouth use the HHDA abutment driver. The driver should be hand tightened (max. 25-30 Ncm) to the abutment to confirm adequate attachment of the tool to the abutment.

Use appropriate abutments and angulated components that correspond to the implant system being restored.

1. Remove the angled abutment from the abutment packaging in a sterile field. Hand tighten the abutment with the HHDA Abutment Hand Driver to confirm the attachment to the cone of the abutment. **2.** Thread dental floss through nose hole in the HHDA top. Utilizing the abutment Driver, deliver the abutment to the mouth. Aligning the angled abutment in the appropriate orientation for desired angulation correction. **3.** Use 1.27mm [0.50"] Hex Driver HHDA to hand tighten (max. 30 Ncm) the abutment retaining screw. A contra-angle hand piece with a 1.27mm MMA driver can also be used for initial delivery. The long MMA driver (MMA-28) must be used if the abutment delivery tool is attached to the abutment. The standard MMA driver (MMA-22) can be used if the abutment delivery tool is removed from the abutment. **4.** Verify with periapical radiograph that the abutment is seated completely into the implant and has engaged the internal hexagon. **5.** Tighten the abutment retaining screw to 30 Ncm with a calibrated torque wrench. The Torque Wrench TRU/RWH can be used with the abutment driver for ratchet RDA-L, removed from the abutment can be used RDA-M. **6.** If the abutments will not be immediately restored with a provisional or final restoration, it is recommended to place the abutment titanium Healing Cap. (HC-xx) to prevent irritation of the soft tissue and to prevent the ingress of material the screw access of the abutment cone.

Instructions for use - Ball-Attachment and Clicq Overdenture

Device's description and expected performances: Retentive elastic attachments for the construction of dental prosthesis.

Precautions: Choosing the right attachment is a dentist or dental technician responsibility according to the prosthetic project. Safety, Responsibility and Warranty: Ritter attachments and components are manufactured in accordance to the Europeans and USA norms on medical devices. No undesired collateral effects are expected or reported. Storage, transportation and cleaning process: Store in a dry and clean place inside the original boxes when possible.

WARNING: Do not create any damages to the packaging while shipping. Product have no expiration date. The product is sold into a NON STERILE packaging, it's recommended to proceed with sterilization process of the metal parts by following the standard medical procedures (steam autoclave sterilization). All the plastic parts (not castable) should be sterilized by cold sterilization using Benzalcynhydrin solution. Technical support: Our technical staff is available to assist you on any type of question regarding the use of the Ritter components.

More information regarding the use of the Ball Attachment & Clicq Overdenture SYSTEM are available on our main catalog and technical leaflets. Maintenance and periodic care: Dentists have the responsibility to keep the proper functionality and retention of the devices (CAPS AND CLIPS) and assuring the safety of the patient by constant care. Guidelines for the patients: Patients are recommended to

follow the indications provided by the dentist, to attend periodical controls and perform daily accurate hygiene. Kits contain: Single implant attachment: 1 titanium attachment TiN (Ø 2.5), 4 assorted retentive caps, 1 protective disk.

TECHNICAL SPECIFICATIONS: Ball Attachment & Clicq Overdenture on implants: Titanium + TiN single overdenture attachment to be screwed on endosseus implants, the retention is guaranteed by the elastic cap which goes over the sphere's equator. Sphere's vertical dimension has been reduced to obtain a smaller attachment.

RETENTIVE CAPS: Different retentive faculties allow to choose the proper retention. Nylon and acetal copolymer material.

PRE FABRICATED METAL HOUSES or TITANIUM: The internal shape is designed to contain the elastic retentive caps. The outside shape is designed to be inserted into resin mobile prosthesis or to be connected by using glue, composite cements or self polymerizing resin to metal parts, cast reinforcements or metal frames.

UNSCREWING SYSTEMS: Expanding nylon elastic towel designed to avoid the unscrewing of the attachment from the implant (available on request).

PROTECTIVE DISK: Mono-use disk, plastic and elastic material, transparent color.

INSTRUCTIONS FOR USE: Ball Attachment & Clicq Overdenture Attachment Titanium + Tin: Screw the attachment to the implant with the proper square screw driver, make sure the insertion of the metal tip is corrected. Screw tightly by hand until the process is completed, than unscrew the attachment and screw it another time. Repeat this process a couple of times until the thread get the proper micro modeling shape of the female part. In alternative screw the attachment by using the proper dynamo-metrical drill extension tool tightening up to 25 N/cm².

APPLICATION OF THE PROsthESIS IN THE PATIENT'S MOUTH: Once the Ball Attachment & Clicq Overdenture attachments are screwed into the implants, proceed with the insertion of the elastic protective disk over the equator of the attachment. Insert the retentive female cap inside the metal house by using the proper insertion tool, choose the female cap with the proper retention according to the case, than insert the metal house over the attachment with accurate pressure in order to have it snap over the equator. Test the resin mobile prosthesis in the patient mouth which will have the proper spaces corresponding to the attachments. Make sure the space is enough, if any interference should occur enlarge the space by using a bur until the interferences with the metal house are removed. Fill up the spaces with self polymerizing resin, insert the prosthesis inside the patient's mouth, verify the correct position, have the patient closing his mouth and wait until the resin is cured. Remove the prosthesis, refine and polish every exceeding material than deliver the prosthesis to the patient. In order to maintain the high quality standard offered by the Ball Attachment & Clicq Overdenture line we recommend the substitution of the retentive elastic components yearly. Any use of the Ball Attachment & Clicq Overdenture system and components which does not follow the present instructions or the others Ritter literature is considered improper.

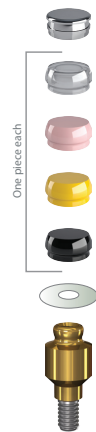

Instructions for use - Multi-Units

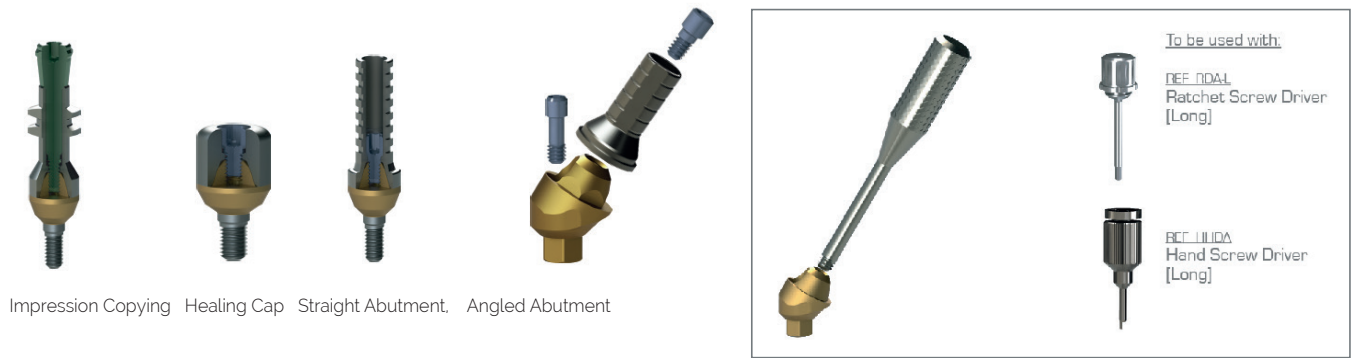

Impression Copying Healing Cap Straight Abutment, Angled Abutment

Device's description and expected performances:

Multi-Units are an Abutment-System joining many different Abutments in one Multi purpose Abutment together: Impression Copying, Healing Cap, Straight Abutment, Angled Abutment for final Restauration.

Precautions: Choosing the right attachment is a dentist or dental technician responsibility according to the prosthetic project. Safety, Responsibility and Warranty: Ritter attachments and components are manufactured in accordance to the Europeans and USA norms on medical devices. No undesired collateral effects are expected or reported. Storage, transportation and cleaning process: Store in a dry and clean place inside the original boxes when possible.

WARNING: Do not create any damages to the packaging while shipping. Product have no expiration date. The product is sold into a NON STERILE packaging, it's recommended to proceed with sterilization process of the metal parts by following the standard medical procedures (steam autoclave sterilization). All the plastic parts (not castable) should be sterilized by cold sterilization using Benzalcynhydrin solution. Technical support: Our technical staff is available to assist you on any type of question regarding the use of the Ritter components.

More information regarding the use of the Multi-Unit-SYSTEM are available on our main catalog and technical leaflets.

Guidelines for the patients: Patients are recommended to follow the indications provided by the dentist, to attend periodical controls and perform daily accurate hygiene.





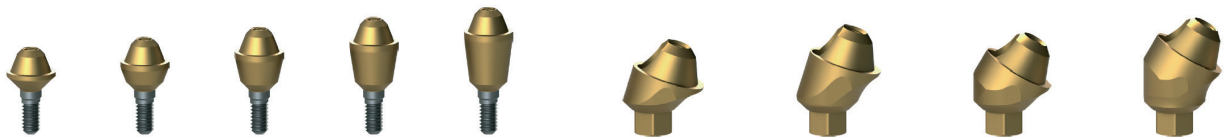









TECHNICAL SPECIFICATIONS: Multi Units on implants: Titaniumbase Grade 5 Abutment attachment to be screwed on endosseus implants.

INSTRUCTIONS FOR USE: Multi Unit Baseattachment: Place the Multi-Unit with the metal handle MU-HD in right position on top of the implant. Screw it to the implant with the proper square screw driver, make sure the insertion of the metal tip is corrected. Screw tightly by hand (up to 25 NCM) until the process is completed. Use angled Multi Units angled base for angle adjustment 17° up to 30°. Also applicable to work with bar restauations for all on 4 / all on 6.



APPLICATION OF THE PROSTHESIS IN THE PATIENT'S MOUTH: Once the Multi-Unit attachments are screwed into the implants, proceed with the insertion of the laboratory final crown. Fill up the spaces with self polymerizing resin, insert the prosthesis inside the patient's mouth, verify the correct position, have the patient closing his mouth and wait until the resin is cured. Remove the prosthesis, refine and polish every exceeding material than deliver the prosthesis to the patient. Any use of the Multi Units and components which does not follow the present instructions or the others Ritter literature is considered improper.

Symbols may be used on some international package labeling for easy identification.

Symbol	Description
	Sterilized using irradiation
 Single Use	Do not reuse
 CAUTION	Caution
	Consult instructions for use
	Do not use if package is damaged
	Use-by date
	Catalogue number
	Batch code
	Do not resterilize
	Manufacturer
	CE Mark with number Notified Body
	Symbol for "Use by Prescription only"
	Non-Sterile
	Temperature limit. Storage condition 10°C-35°C/ 50°F-95°F

Ask for more Information and coming events

Distributor · 4310 West Avenue · San Antonio,
Texas 78213 · Phone 1.855.807.8111

Manufacturer:

Ritter Implants GmbH & Co. KG
Freiburger Straße 45 · 88400 Biberach ·
Germany Phone 0049 7351. 52 925-10
www.ritterimplants.com